

↑
3

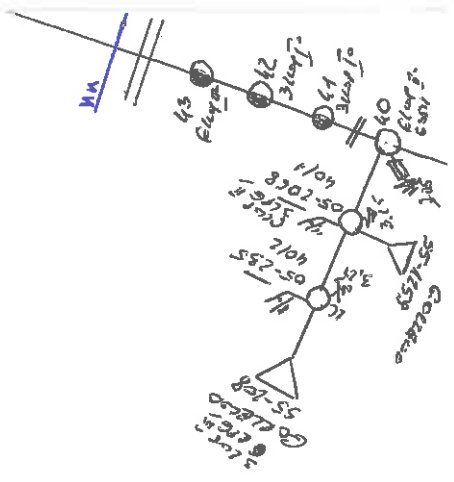

→
1

4

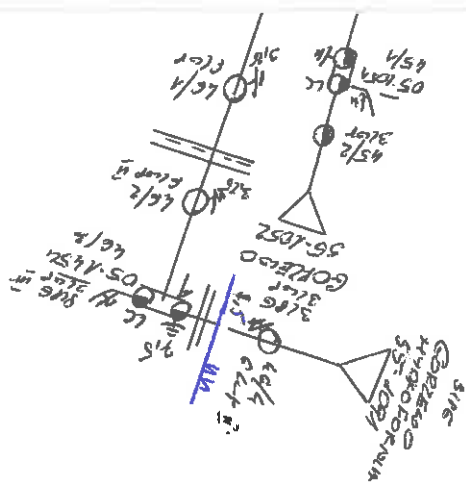
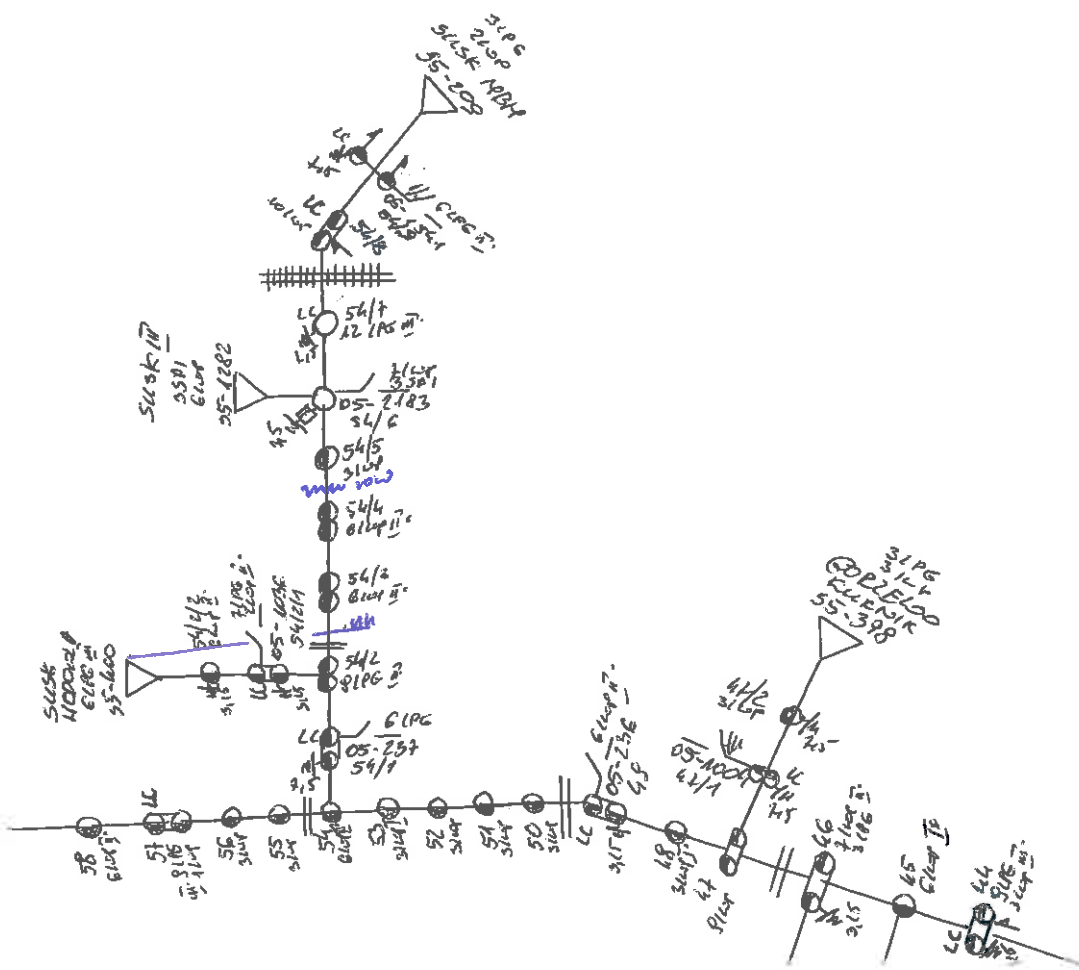

Nr.3

Nr 4

3 →

↓ 5

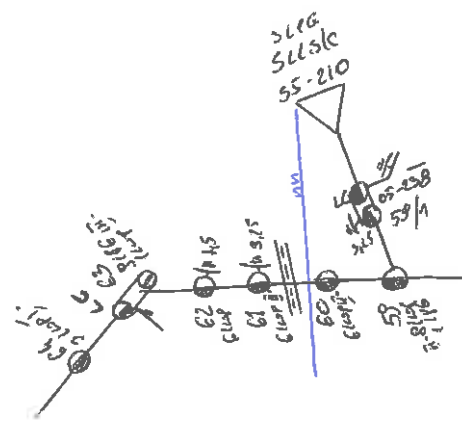

Nr.5

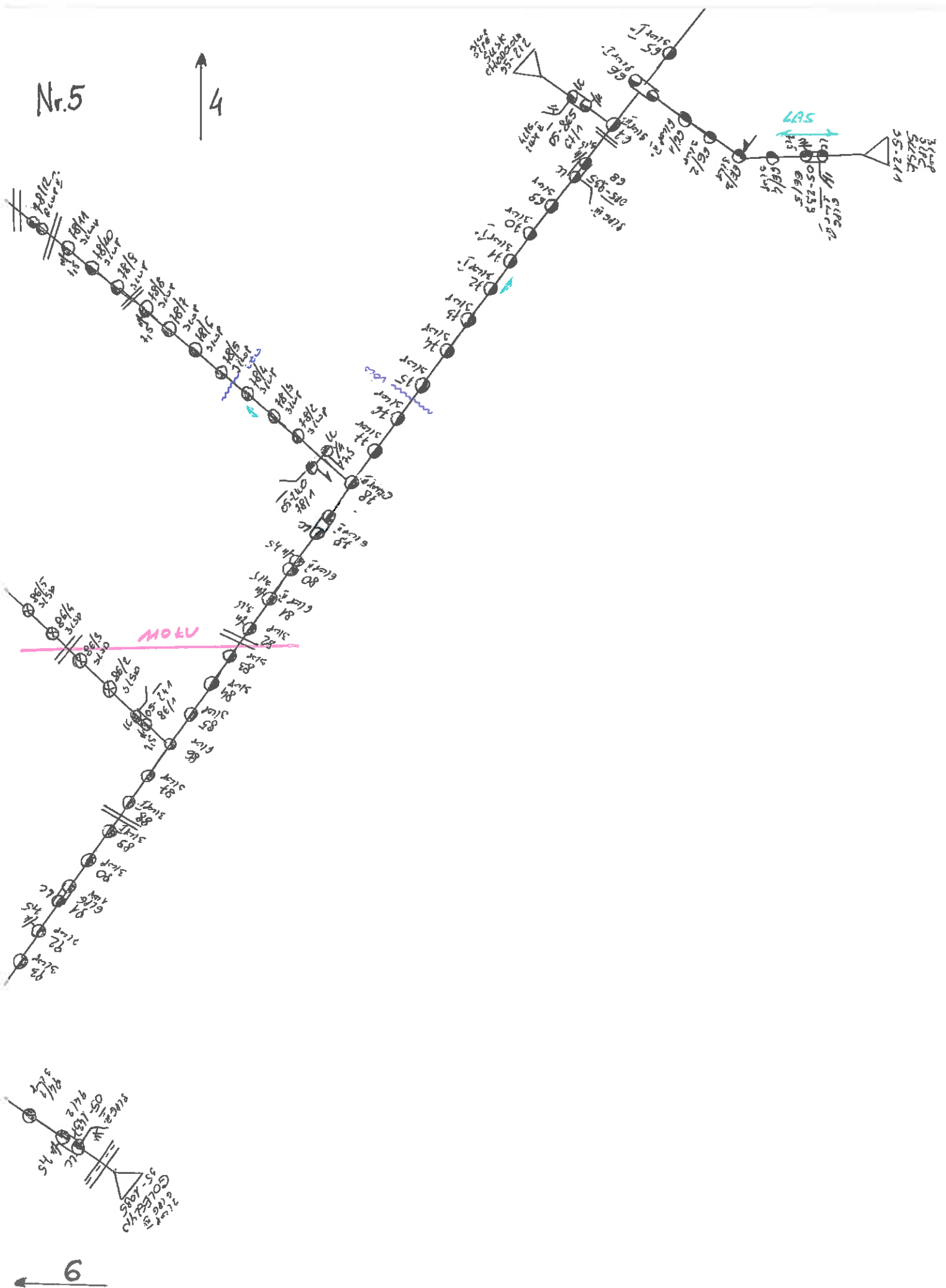

6

Nr. 7

6

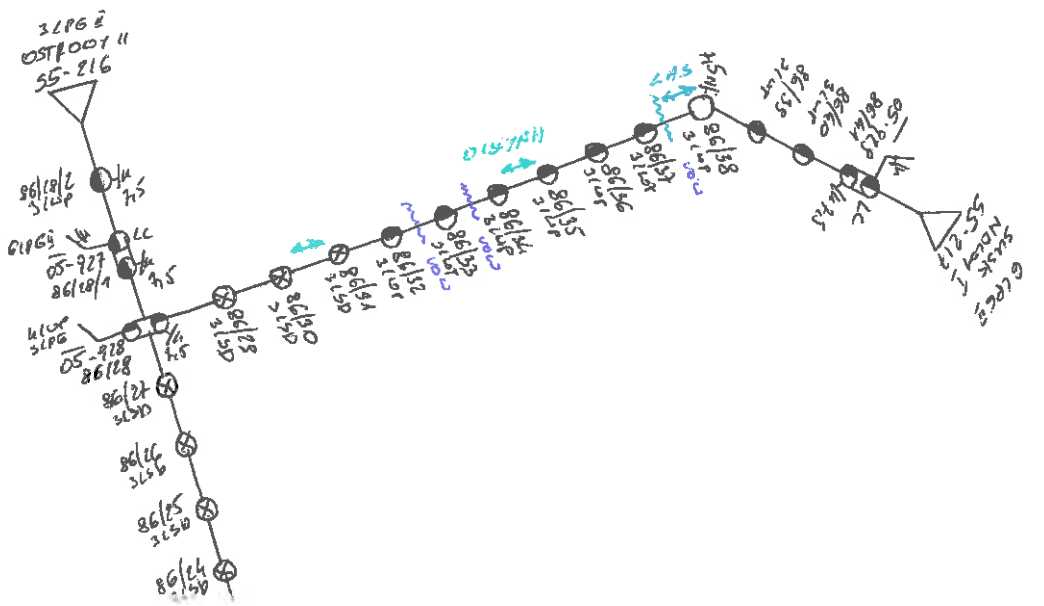

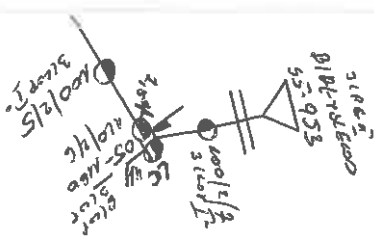

↑
6

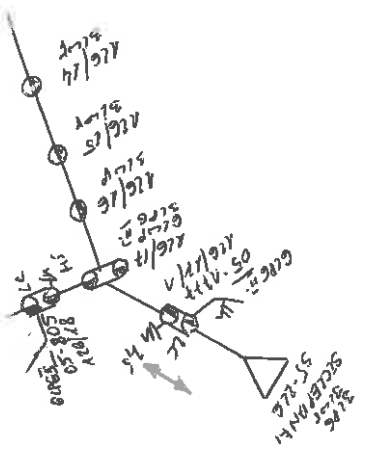
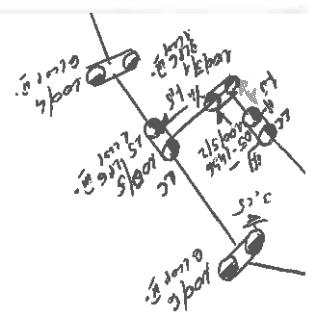

← 12

→ 9

Nr. 8

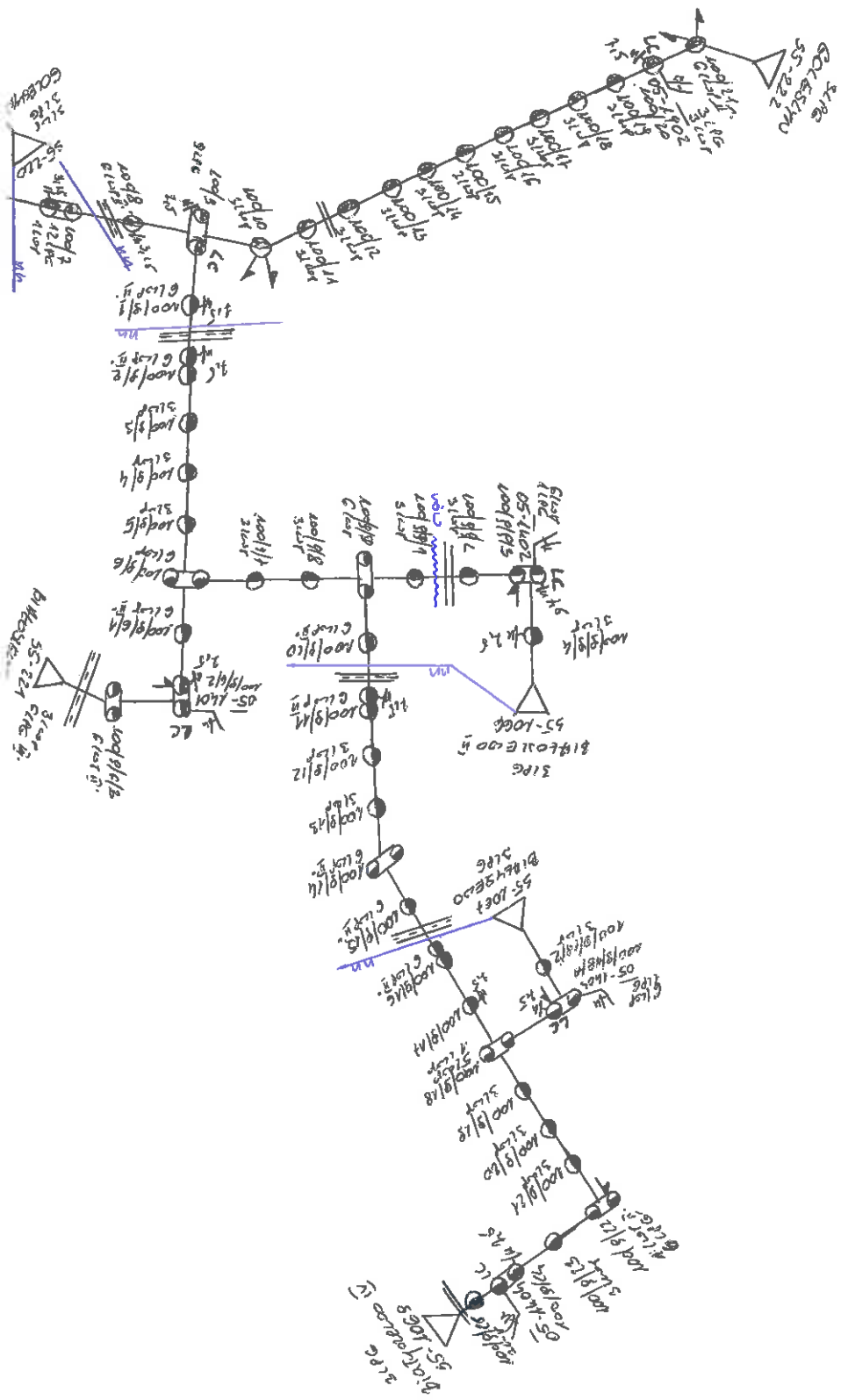

← 8

Nr. 11

← 16

→ 10

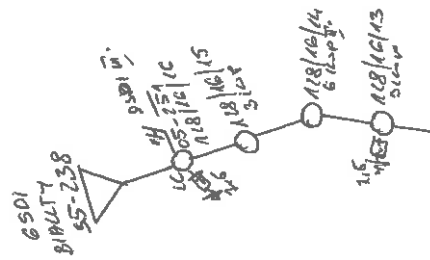

↓ 14

142
slit
141
slit
140
slit
139
slit

Nr. 12

10

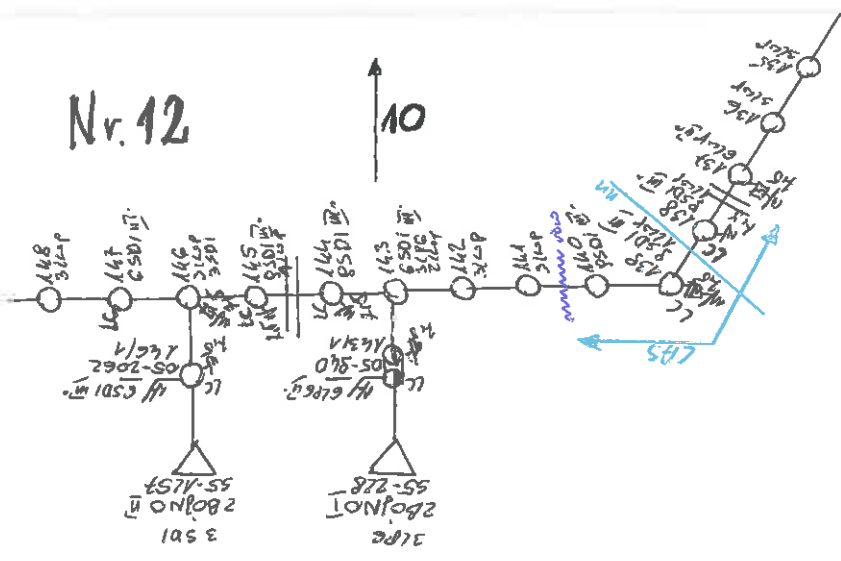

14

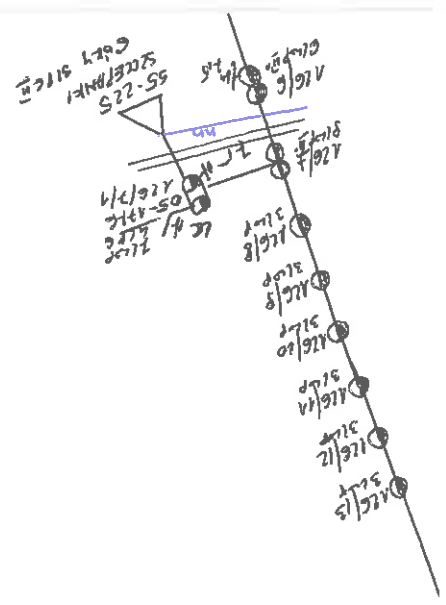
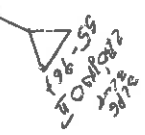

31PG 2BOJNO I 55-227

31PG 2BOJNO II 55-228

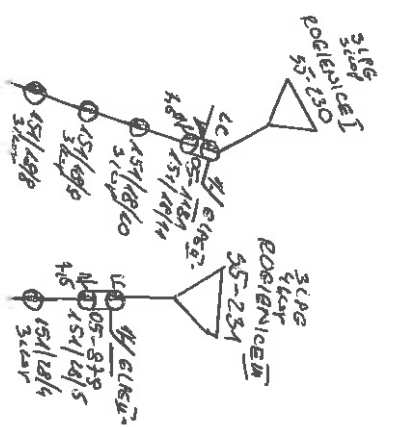

31PG CETLIN II 55-974

31PG CETLIN I 55-235

8

13

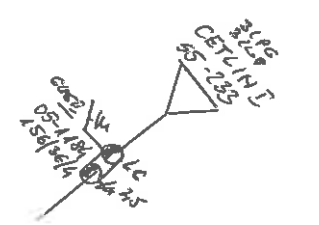
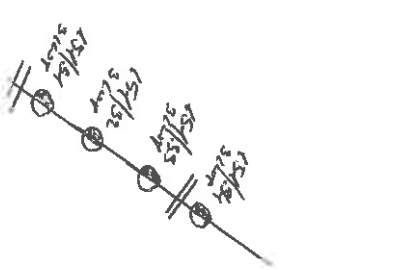

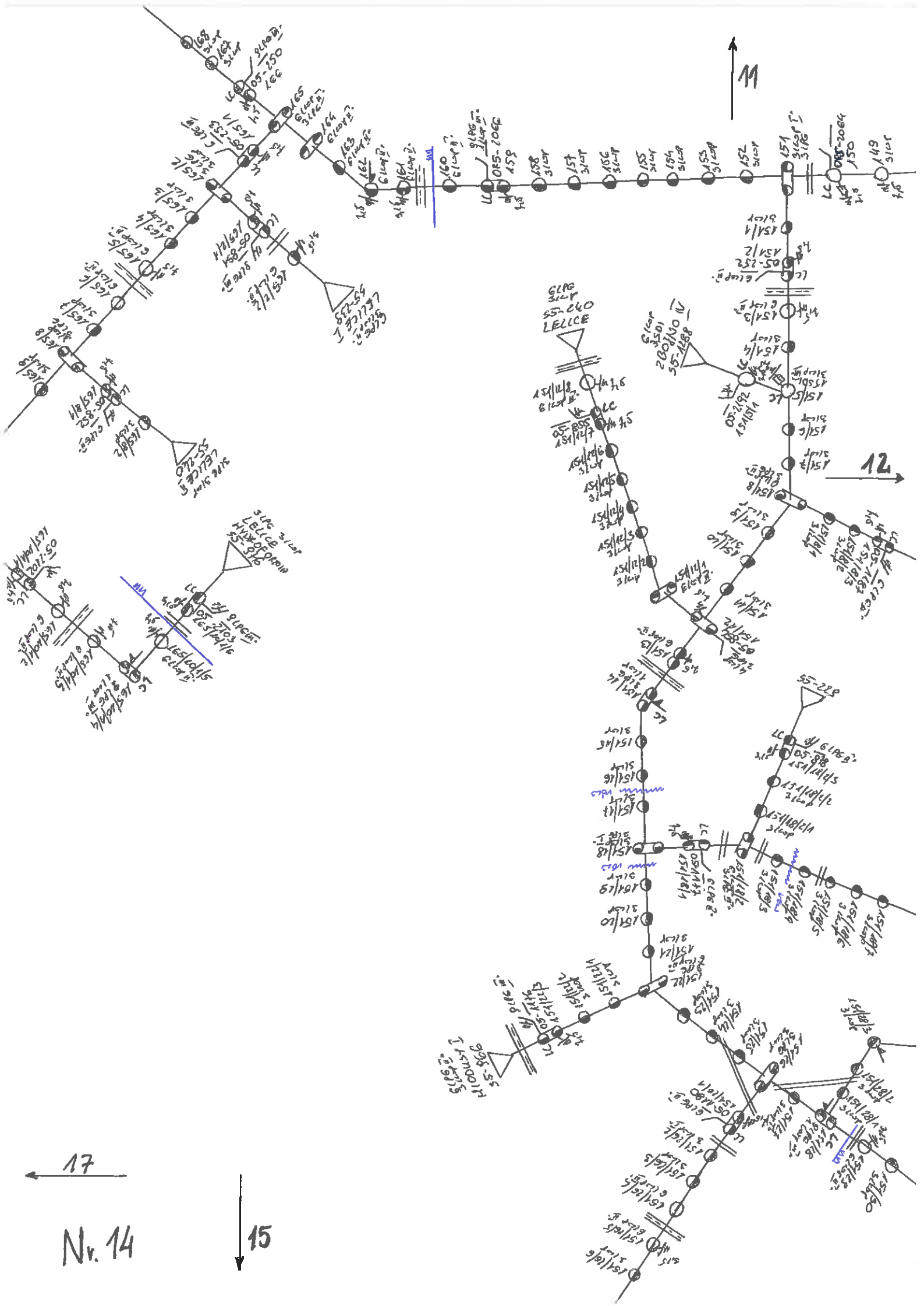

Nr. 18

↑ 20

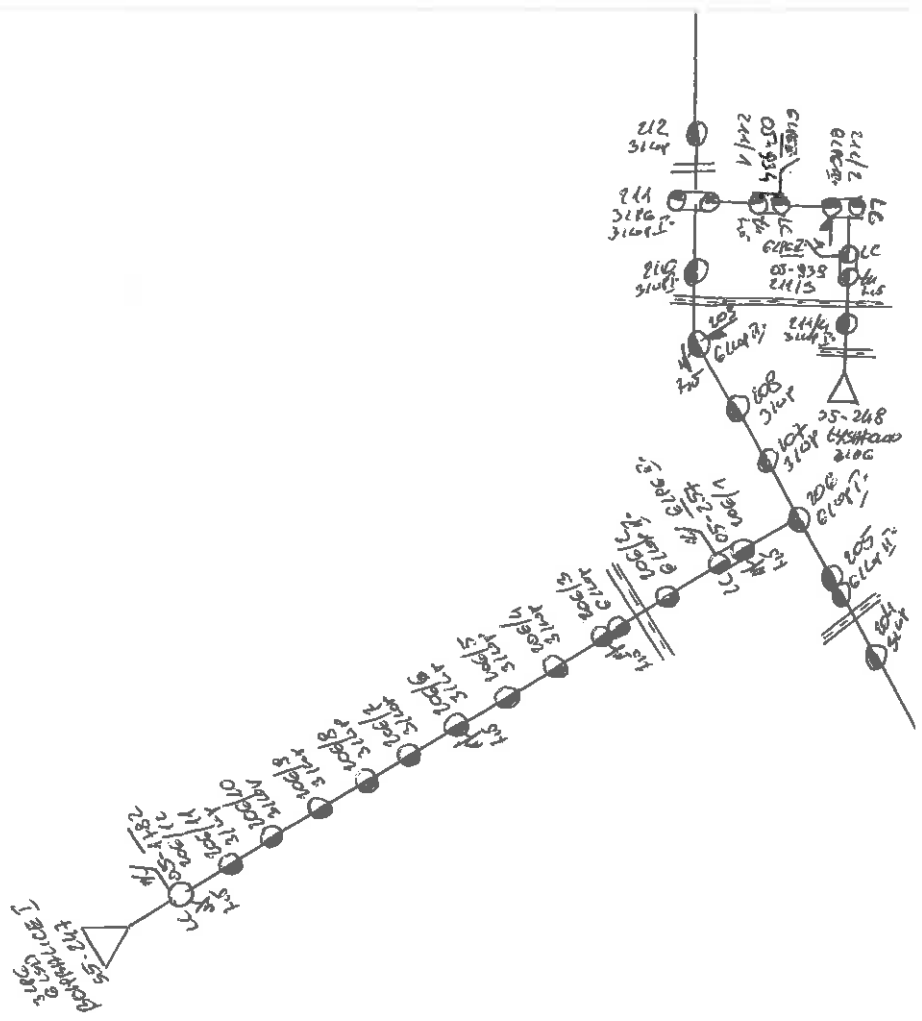

→ 16

↓ 19

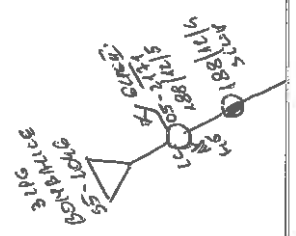

Nr. 19

